



Diastam

evolution of oral care

Presentation of Diastam LLC, Tomsk city, Russia

Dental diseases which adversely affect general well-being and result in many somatic diseases are one of the most serious health problems in Russia and worldwide.

Gingivitis, parodontosis, periodontitis, caries are the most pressing ones.

World Health Organization states more than 50% children and more than 80% adults worldwide suffer from various dental diseases. The best preventive measure is therefore the correct and effective teeth brushing and oral care.

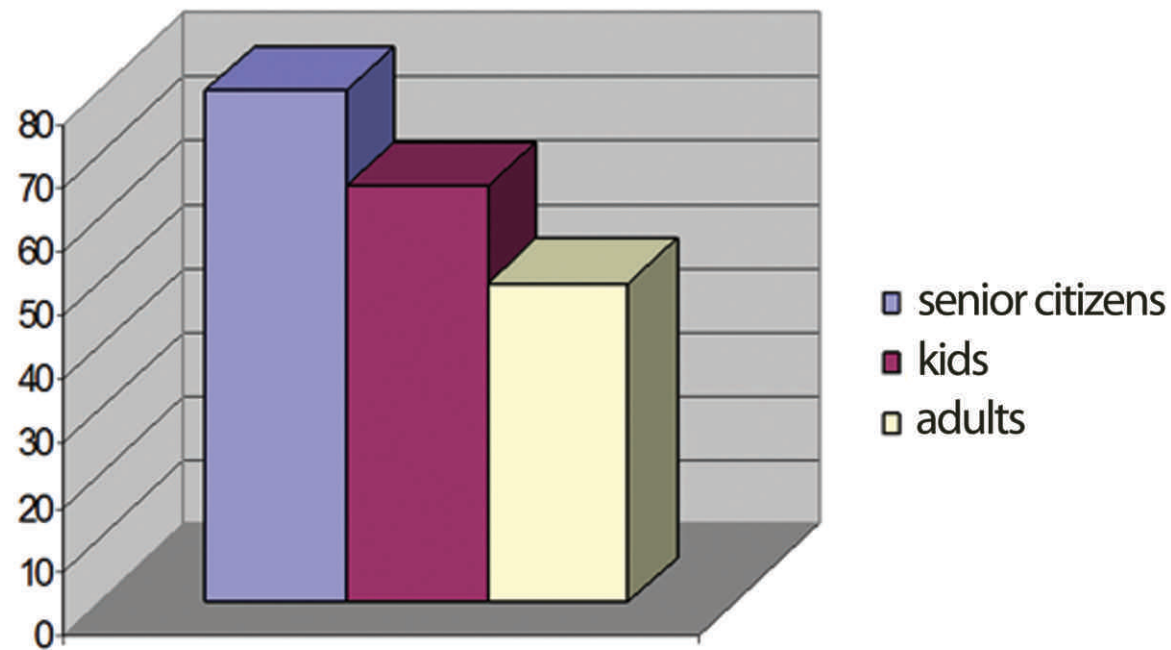

Diastam LLC is the company engaged in the development, certification and introduction of innovative oral care products to domestic and international markets.

We present technologies developed by the Russian scientists with patents in RF and international applications launched.

LED toothbrush **LONGA VITA MaxPhoLight** is already on offer.

LONGA VITA

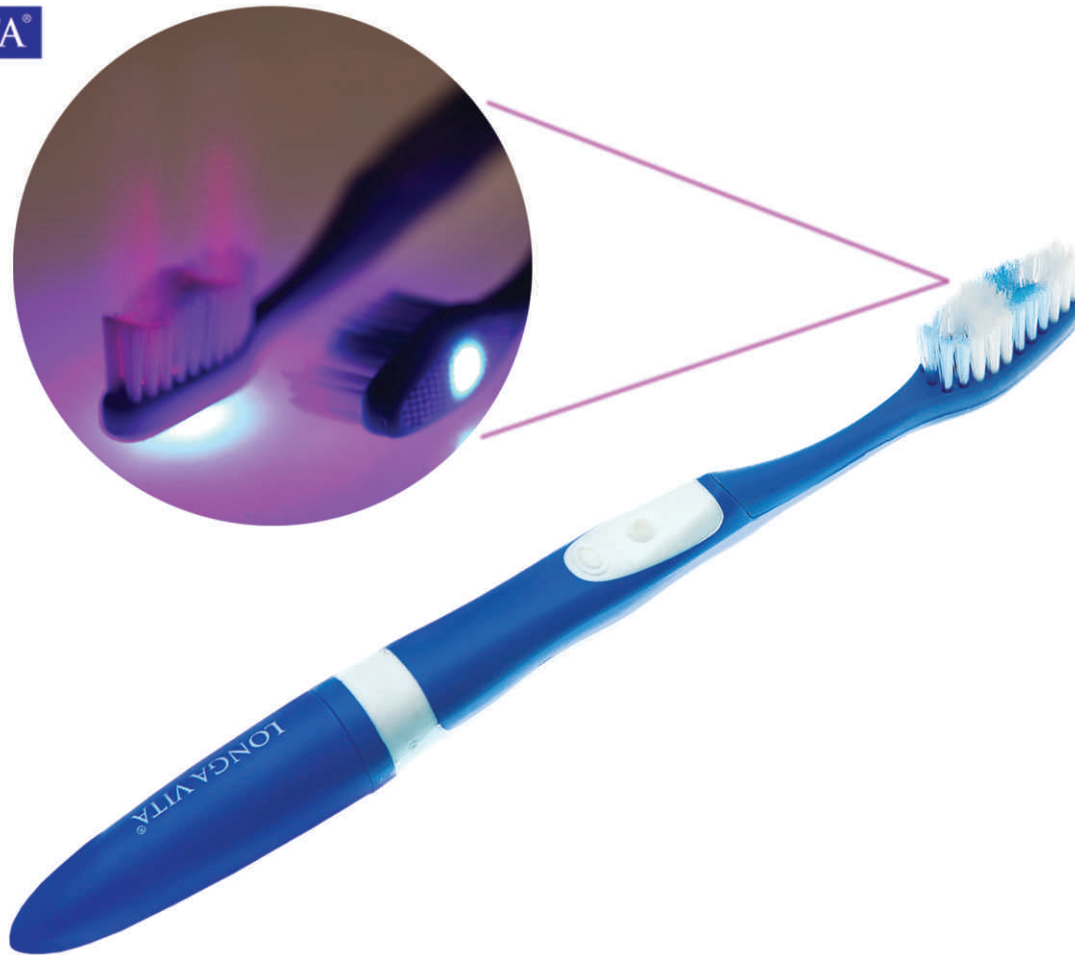

Accumulating all advantages of available tooth brushes **LONGA VITA MaxPhoLight** offers highly effective prophylaxis, sanitation and treatment of the widespread stomatopathy: acute and chronic catarrhal gingivitis, parodontosis, stomatitis.

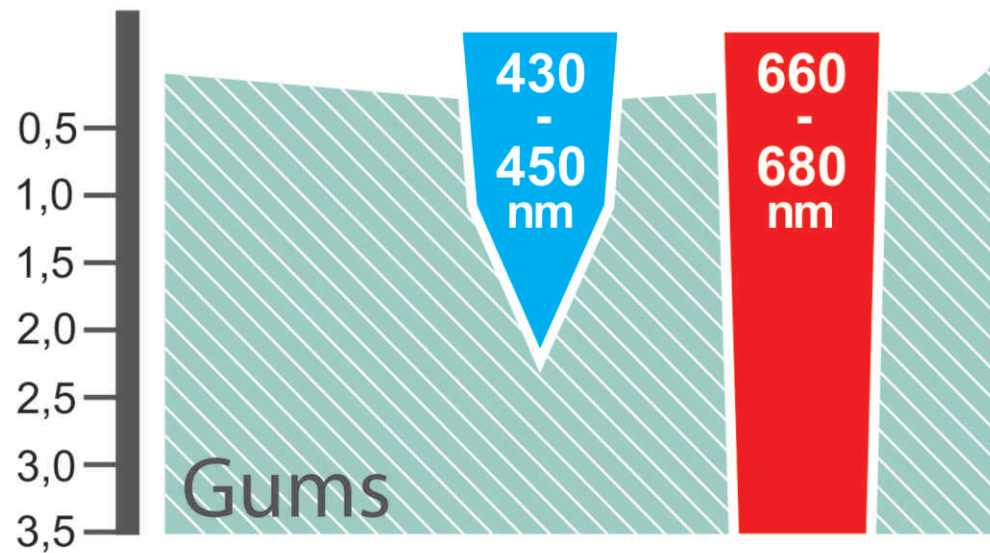

LONGA VITA MaxPhoLight health improving effect is based on photodynamic therapy method and is provided by means of red and blue radiation.

Red light radiation:

- improves blood circulation and nutrition of tissues
- stimulates recovery processes in cells, while improving the state of the oral cavity
- activates metabolism

Blue light radiation:

- removes inflammation of gums
- provides an antibacterial effect

Special LONGA VITA toothpaste intensifies the curative and prophylactic effect due to the interaction of the LEDs in the toothbrush and active oxygen extracted from chlorophyll in the toothpaste. During red spectrum radiation chlorophyll produces active oxygen which eliminates pathologically modified cells and inflammatory microflora of the oral cavity.



Unique LONGA VITA toothpaste:

- stimulates immunity of the oral cavity
- eliminates a pathological microflora
- reduces inflammatory processes in gums and their bleeding
- suppresses production of acids harmful to the enamel and prevents caries development

Three more innovative toothbrushes are being developed and designed.

Sector toothbrush

Operating principle: 6 segments in the replaceable toothbrush head provide for the right cleaning direction by sweepings. Movements of three segments are directed to one side while the other three segments move to the opposite side. It enables to achieve maximal effect during tooth brushing and prevent the toothbrush from slipping.

Oral-B Deep Sweep 5000 SmartSeries with Wireless SmartGuide™ Electric Toothbrush is our only competitor on the market. However there are stationary bristles and sweeping ones provided in Oral-b's toothbrush while we design only moving bristles for the most effective cleaning.

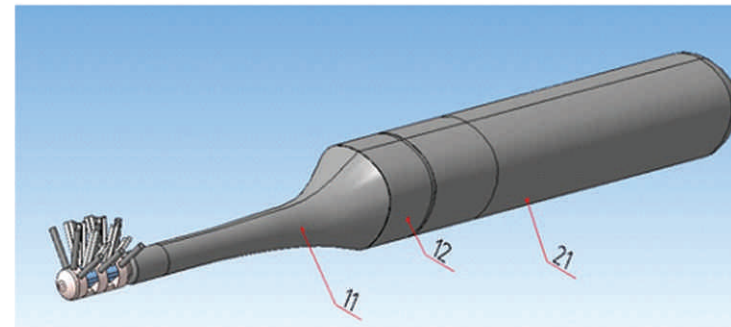

The moving bristles in our toothbrush enable us:

- to make brushing double more effective
- to remove up to 100% more plaque, even between teeth, vs. a regular manual toothbrush
- to reduce gingivitis up to 3X better than a regular manual toothbrush
- to ensure deep between teeth cleaning due to 8,800 sweeps per minute

Two-brushed toothbrush

Operating principle: any position in the mouth provides a correct brushing of the teeth. This is the first toothbrush in the world which provides the ideal tooth brushing method recommended by all dentists – its bristles move in only one direction – from a gum to the top of a tooth crown, thus cleaning teeth tenderly, without hurting gums and making tooth brushing a pleasant process.

2 brushes enable us:

- to embrace both sides of teeth and clean their inside and outside surfaces simultaneously
- not to loosen interdental papillae. The brushes do not harm dentogingival pocket, and, therefore, do not cause bleeding while brushing
- to massage the gums properly, thus quickening their healing when gum inflammation occurs
- to prevent dental calculus formation and bad breath
- to ensure an increased productivity of the brushing by a large contact area of brushing filaments with the surface being brushed
- to save up to 50% of a tooth paste intensively foaming it in a mouth cavity

A light touch of brushes to enamel is sufficient for effective cleaning. The lower the pressure on enamel, the more effective tooth brushing will be.

We plan to simplify the design of the toothbrush. Single-shaft toothbrush will be more convenient for the users.

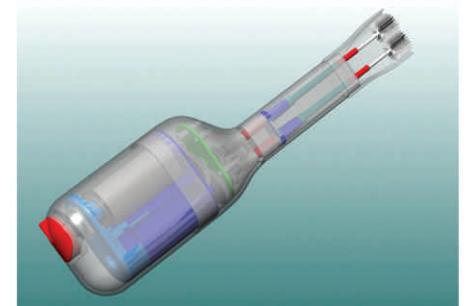
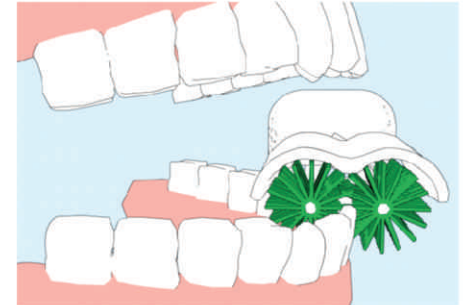

New Action toothbrush

Operating principle: equipped with trapezoidal replaceable brush head which embraces a tooth from three sides at once and cleans teeth in three directions simultaneously. The same ensures:

- total cleaning of both buccal surface and lingual surface of the tooth
- effective massage of the gums with their quick healing in case of inflammation
- polysaccharide pellicle maintenance on the enamel surface and stimulation of its remineralization
- dentogingival pocket safety preventing dental calculus formation thus contributing to the disappearance of bad breath
- easy control of the frontal teeth cleaning intensity by a simple turn of a handle

Silicone brushes with soft thick bristles are used instead of ordinary bristles we got used to. Hollow type bristles are also an option for better tooth paste penetration between the teeth.

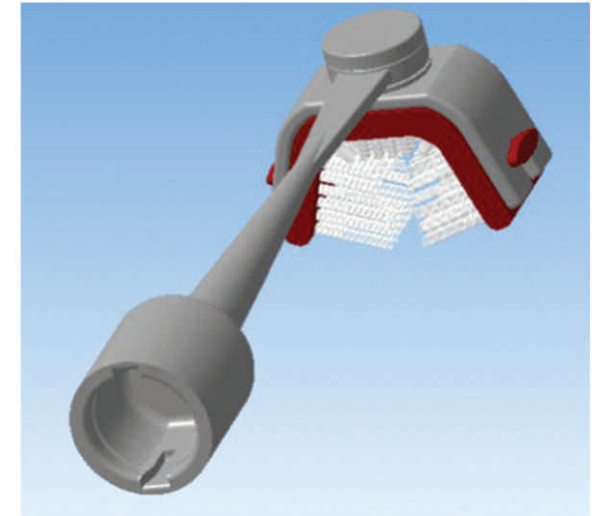

New Action toothbrush is especially recommended:

- for people wearing different types of brackets. Even in this case they provide perfect enamel and interdental spaces cleaning
- for kids who generally do not like to clean teeth with usual tooth-brushes. New Action cleaning heads do not require any special skills from a user, they are very easy-to-use
- for people with sensitive gums suffering from gingivitis and parodontosis

LED display without protecting screen is one more peculiarity of the toothbrush. The same is intended for the cartoon/animation to be inserted or name personification.

LED display can be easily programmed and is an option to attract children to the teeth brushing.



Price policy ensures business stable profitability, availability of the innovative toothbrushes for the people as well as compliance with the price range of the competitive analogues. However most of the projects do not have any competitor.

Diastam

evolution of oral care

Thank you for attention!

Please visit our website www.longavita.su for more information on the products available.